

HUSTLER

Journal of the kit car élite

no. 9



Happy New Year to you all. I hope you all survived the Christmas festivities intact. There are some very good articles in this issue, mainly on fitting larger engines into Hustlers. I am sure many of you have been working on your cars during the winter, so why not send an article in for the next Newsletter No. 10 which is due out on 1st April 86.

SUBSCRIPTION time again for all Club members up to number 071. If you could let me have them in by 1st April in time for Newsletter No. 10 Its still only £4.00. inflation is taken care of by the few pennies profit we make on the Keyrings, so please keep on buying them. I have still got hundreds.

What I would like is for someone or a couple of club members to take over as Events secretary for me as I am hoping to move into a new business venture sometime during the year and I may not be able to represent the club at all the shows during the next Summer. Whoever offers to take over I will let them have all the Club bits and pieces, the sign boards and flags etc. I would like us to continue with a Club presence at all the Major shows because our attendance is always keenly sought by the show promoters and we are quite a popular attraction to the paying public. I of course will still continue to publish the newsletter and run the admin side for the club. If anybody is willing to take over the events please phone me here at Aldershot. Also if anyone would be interested, I have for sale the more modern caravan I purchased last year. It is ideal for Weekends and holidays. It is a 1974 FAIRHOLME Rosefinch, 10ft long Max. gross weight 15cwts. Super luxurious interior including Gas Fridge. 2 berth with awning. Towable by a well tuned 1300cc Hustler. Price £400.

The reason I have decided to go into business for myself is that under my present lifestyle I can see no way that I will ever be able to afford to buy a Hustler Highlander without robbing a bank, and as that is not quite my style the only alternative is to (cream off £10,000) sorry, I mean, to set against justifiable tax allowances for business purposes. So that eventually I can buy a Highlander, if all goes according to plan. On the other hand I could end up completely bust, but I have still got my Hustler six to comfort me. I will keep you all informed of my new address when I move.

For Sale HUSTLER OWNERS CLUB HEADQUARTERS. 2 Bedroom Semi detached Bungalow Large Garage ideal for Hustler building. Good size front lawn, ample room for 4 or 5 Donor vehicles. Good driveway enough room for 2 or 3 more donor vehicles. Situated in private cul de sac. Very tolerant neighbours. Good London commuter address 40 mins. to Waterloo.

Asking £54,000 (seriously) I need the money to put towards the business.

7/28/86

After removal of the upper chassis frame of the Sprint, the next task was to extract the engine and gearbox together with the front subframe. After draining, disconnecting and dismantling around the engine, the subframe mounting bolts were tackled. Those at the front were well rusted, and both sheared easily. The top bolts had rusted heads which had to be unscrewed using non-standard sockets. The front of the body was raised to allow the subframe to be wheeled out forward. After splitting the engine from the gearbox, the subframe was temporarily replaced to allow mobility of the rolling chassis.

The fuel tank was a large Volvo item located inside the car between the rear wheels, taking up most of the load carrying volume below the window line, and a replacement was planned for the rebuild. The carpet covered wooden deck and bulkhead hiding the tank were removed, followed by the tank itself.

The engine surround moulding was then removed after further dismantling, revealing extensive rusting of the lower chassis frame. With the pedals and steering column removed, the main body moulding with seats still attached was then extracted from the lower frame.

The rear subframe was then removed and dismantled for refurbishing. It was noted that at all front and rear subframe mounting points on the chassis, the chassis tubes had been deformed, and fretting of bolts and holes had taken place. This will be minimised through the use of round tube inserts as shown.

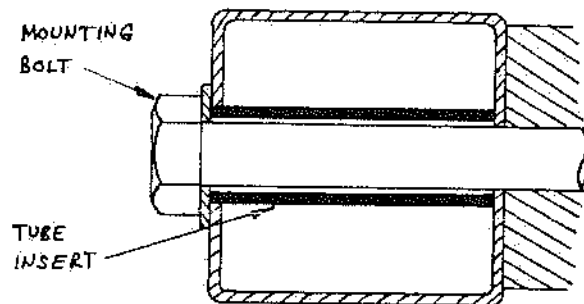

The lower chassis frame and rear subframe were subjected to the procedure of stripping all paint, grinding and treatment of rust with Trustan, followed by Finnigans No.1 primer, then Hammerite for all surfaces except the side rails, which will receive the exterior gloss colour when chosen.

The main body moulding was further dismantled for full refurbishment. The final choice of location for the replacement Reliant Robin fuel tank was beneath the passenger seat. The moulded well behind the seat area, previously used for storing tools, was cut off at floor level, and GRP sheet laminated in to fill the aperture. A flanged box was then fabricated from GRP sheet to fit closely around the tank, to protect it from corrosion and other damage, and to enable it to be bolted to the underside for easy removal and access if required. The underside of the moulding was rough and starved of resin in places, and extra resin was painted on after cleaning to achieve a smooth weatherproof surface. Some areas, such as the steering rack mounting area and the forward base of each footwell, were strengthened with additional glass mat and resin. Taking care to maintain necessary clearances, soundproofing felt was glued to selected areas of the underside with resin, later followed by overlamination with glass mat and resin to seal out moisture.

A footnote to my letter in N/L No. 8.

Members might be wondering why I've gone to so much trouble to put a Maxi engine in my wooden 6 rather than "do up" the original 1300 engine?

Well there are a number of reasons :-

1) Before starting to build the car I knew the weight of a wooden 6 to be much heavier than that of a metal and fibre glass 6. (so I wanted a bit more power without the hassle of doing up the 1300). This was confirmed when I went and got it weighed. To my astonishment it weighs a staggering 1110 Kgs -that's over a ton. No wonder the 1500 engine is finding it hard work!! So what would it be like with a 1300 in?

2) The 1300 engine and gearbox out of the donor car was shot which would have meant re-vamping the whole unit and I already had a 1500 Maxi unit that was in reasonable condition.

3) I wanted the 5th gear as an overdrive. But because of the weight of the car the 1500 can't cope very well. At present I've got a complete 1750 unit but with a shot gearbox so as soon as I can get hold of a new gear box I intend to replace the 1500 unit with the 1750 unit then maybe 5th gear will be useful as an overdrive. (The 1500 and 1750 gearboxes are not interchangeable)

4) I want to be able to tow a trailer tent so now the 1750 is a must.

Overheating!!

Well not actually over heating in the true sense. More a case of every thing getting far too hot due to the lack of air circulating around the engine compartment, which meant that the oil was getting very thin. Therefore, because it was thin it wasn't lubricating efficiently, therefore, more friction, therefore, more heat!

Because the engine 'lump' was getting hot, so too was the carb. When very warm the engine use to behave as if suffering from fuel starvation. I have since found out from the experts that the cause is due to the petrol vapourising before it gets to the carb hence causing fuel starvation. To overcome this problem I have fitted the asbestos heat sheild that is fitted on the Allegro 1500/1750's to my Maxi engine (it fits between the carb and the manifold and shields the carb from the heat coming off the exhaust manifold). Instant cure!!

The other problem of the lump getting to hot because of poor air circulation (and the fact that wood retains heat very nicely) I solved by refitting the existing fan ie I bolted it back on to the water pump pulley. The hot air is now drawn out of the engine compartment as it was originally designed to do. I've also made a cowl above the fan to direct as much air as possible out via the nearside wheel arch and also as a safety measure to prevent me loosing any of my fingers !!

Rear Wash/wipe

I have now fitted the rear wash/wipe. I've used the unit off the Ford Sierra Estate which you have to buy in 'bits' form. IE. I bought the motor, wiper arm (which comes complete with washer jets (early type has one jet, later type has two jets)) and the rubber grommet which fits in the hole in the glass. The washer motor etc I already had. The wiper blade I used is a 15" one not a 13" as on the estate. Works very well.

They look very good. I ended up fitting two because I got a good deal for the pair off my local car accessory shop. (If I'd not put two in the Hustler one would have gone in the other car!!) They certainly help to keep the temperature coolish inside the car on warm days. I'd certainly recommend at least one.

Front Windscreen Wiper

I've changed the 'box' from the existing one off the 1300 for the one from the offside of an Allegro. The 1300 had too much sweep in heavy rain and the wiper blade was sweeping off the screen at the bottom and the side. The Allegro is a little better in so much as it has a smaller sweep but I would have preferred it with a little more sweep. What I need is a box with a gear in between the 1300 and the Allegro. Still it's better than the 1300 'box' and at least it's not wiping the bonnet as well!!

Rear Wheels - Tyres Rubbing

I wonder, has anyone experienced the tyres rubbing against each other when there are passengers in the rear of the car? This is due to the rather small amount of clearance between the rear wheels and is reduced even further when the suspension is loaded. Seems only to be a problem with wooden 6's. Would fitting low profile tyres solve the problem??

Dear Trevor,

Just a short note to let you know that I've now fitted the 1750 'lump' to my wooden 6. What a difference!!! There is quite a bit of power there now - which isn't bad considering the engine I've put in has done 95,000 miles!!! My MPG has now gone up to a respectable 30+ to the gallon and the car is much more of a pleasure to drive.

The cartoon enclosed, I think you'll agree, is very appropriate.

Anyway Merry Christmas & A Happy New Year again,

Yours Sincerely,

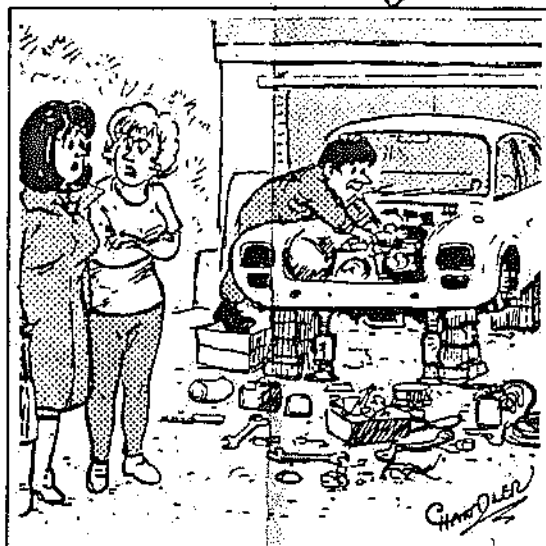

'There was one weekend last May when we came within one wheel-nut of getting it on the road'

1800 MECHANICS.

On reading Keith Sharp's account of his unusual Hustler in Newsletter No. 8 I thought I would put pen to paper about my hare brained ideas.

My introduction to Kit Cars was when I saw a friend's 1800 c.c. Marlin in the course of construction. I was immediately infected with the disease "dismantulitis rebuilddifferent-osis!" so I built a "Gentry". Good fun it was too and I enjoyed 18 months of poser-motoring.

However, my rapidly growing Son and Heir was becoming more and more cramped in the back, so something with a bit more room was required. Enter Hustlers.

After seeing the vehicles at Park Farm I went home to have a think about it and after speaking to one or two people thought that the vehicle might be a bit under-powered (did you think that too, Keith?). I had in the past, owned a couple of Austin 1800's and found them to be capable vehicles, and, since I had done some work on them, thought I knew how they went together. So why not an 1800 Hustler?

The first thing I did was to go to my local friendly scrap yard and take various measurements etc. (I did try a car park, but got funny looks from passing policemen etc.) and decided that the differences between minis and 1800's was surprisingly not that much. Not insurmountable anyway. I decided to go ahead and sold the Gentry to finance the project.

I bought my 1800 for £25 and started dismantling. At the same time, I ordered a wooden 6 Kit. I chose a wooden kit because:-

1. It was cheaper
2. I thought it would "modify" to fit my mechanicals easier.

The 1800 has no sub-frames. Engine, suspension etc., are secured to strengthened parts of the body at the front and at the rear the two trailing arms are bolted to the floor. A custom-made chassis would be the answer - so I bought some metal and started welding. At the rear, attaching the trailing arms was simplicity itself, but at the front I decided to cut the 1800 body off and leave a "subframe" behind to include suspension - including displacer tunnel, steering rack, engine mounts etc. I then joined the two halves together and got a 6 wheeled rolling chassis.

I am now building the bodywork and initial experimental fittings of body to chassis appear to nearly fit so will write more when I have finished digging all these plywood splinters out of my hands.

Martin Guinan

(MARTIN GUINAN)

KIDDERMINSTER

FIRE!

Looking through my back copies of our club Journal, I was surprised that there did not appear to have been any articles on that dreaded subject of Fire! Having owned a number of glassfibre cars and seen just how quickly and strongly fire can take hold, I have always made it a rule to carry a good fire extinguisher in whatever car I or my wife own. The following article may, I hope, prove of interest and use to fellow members.

Let us commence with a description of Fire types:

- 'A' Type. These are fires of solid fuels like wood, upholstery, glassfibre etc.
- 'B' " Fire relating to liquid fuels such as petrol, diesel, maths.
- 'C' " Gas fuels such as butane, propane are associated with this.
- 'D' " Under this heading come combustible metals such as magnesium, aluminium and, in certain cases, wire wool.
- 'E' " All the fires mentioned come in this heading that include high-voltage electricity that gives risk of electrical shock.

All fire extinguishers are (or should be) marked as to their suitability in dealing with some/all of the Fire types above - but it must be noted that in the case of an electrical fire, an extinguishant that is non-conductable must be used i.e. Dry Powder or BCF.

Now moving onto the contents of the extinguisher unit - the first that springs to mind is good old H₂O (water). Quite good for ordinary (i.e. non-electrical) fire because it cools the burning ~~liquid~~^{object} and heat is a prime requirement for fire. Apart from its obvious unsuitability where electricity is concerned, water does present considerable difficulties when you wish to carry it in your car.

Dry Powder - originally based on Sodium bicarbonate (yes, the good old stuff you took the 'morning after' that binge the previous night) this was superseded by Ammonium phosphate and is known under the term ABC (see fire types above). Its main disadvantage is that whilst it suffocates fire by blanketing the burning substance with dry powder, it can be blown off said object in strong winds - it also necessitates very thorough cleaning and strip-down of engines - especially the carburettors. One big advantage is that it is cheaper than BCF units.

Halons - normally known as BCF (Bromochlorodifluoro-methane - yes, it IS a mouthful isn't it?) these act against a fire in Types A, B, C & E. It must be remembered that they are slightly toxic and therefore care should be taken in confined spaces and that after the fire really is out, that the area should be thoroughly ventilated. BCF units are generally more expensive than Dry powder but more efficient.

Now comes the big question -- which type to plump for? As already stated, dry powder is cheaper but does have disadvantages that it is messy and can be blown about whilst BCF is clean, not generally affected with strong winds dispersing it. It is generally accepted that BCF is the best type for car fires in spite of its initial higher cost. Recommended minimum size is 1 kg. (2.2 lbs) even though some firms state that their smaller sizes are adequate for most 'average' fires. If you have ever seen how quickly a fire takes hold of a glassfibre car, then it makes sense to get a large unit and I would suggest one of 2.5 kg. or larger - some fires can take an awful lot of extinguishant to subdue....

Continued over....

FIRE

Dry powder units are sold under brand names as well as under some of the car manufacturer's own name i.e. Ford, Renault, Toyota, Honda etc. The cost is generally around £12.-£17.00 BCF also are sold under some car manufacturers' names (i.e. Ford) and cost between £20.00 to £60.00. Most units sold in shops are O.K. but generally are not of the higher quality produced by the fire specialist companies. When looking at a fire extinguisher you should bear in mind that a unit that has facilities for supplying a refill service is better than one that is the 'throw away after use' type. Refills are roughly half the initial cost. As a rough guide, you would expect to pay between £25.00 - £35.00 for a good BCF rechargeable unit. You can, of course, get the small aerosol-type canisters such as 'Nero', 'Firejet' etc. but they are small, squirt out their contents in one, brief session and really are of little use in any substantial fire - certainly not where glassfire is concerned.

One very useful device to note is that units can have either the total discharge triggering or the controllable (interruptable) trigger. The former pumps out all the contents in one go, once you have squeezed the trigger whereas in the latter you can stop firing the extinguishant should you wish - perhaps to see if the fire really is out or perhaps to tackle another part of the car that is also on fire. The additional cost of this facility is very little compared with its obvious advantages.

Fire Blankets and foam are other fire-fighting items. The former is really only for use at home where burning fats etc. require the flames to be suffocated - a car's engine bonnet acts in much the same way and that is why you should never open wide the bonnet in case of fire - the inrush of air merely helps feed the flames with oxygen. Always try to squirt the extinguishant through the air intakes or, failing that, only lift the bonnet just sufficiently to squirt the BCF/Powder unit into the engine bay.

Foam, on the other hand, really comes under the heading of water, it is comprised generally of water with foam-inducing chemicals added and usually is contained in large, heavy units - more for home/factory use. In any case it is not safe where electricity is involved.

Where to put the unit? Well, in the case of a car that has a boot, then not there since it means you waste valuable time getting to it when you should be fighting the fire. Next, not on the back shelf or where direct sunlight can reach it - canisters have been known to explode - although that likelihood during this year's "summer" shouldn't have counted much! Most manufacturer's give instructions on where and how to mount their units but you should remember that it needs to be mounted upright, out of the reach of heat and within easy reach.

I have not dealt with the type of unit that is so popular with racing people - i.e. the piped-in assembly where the engine bay and/or cab has pipe-work leading from the extinguisher and is either triggered by excess heat, or the driver. This is an excellent system and can save valuable time but it is generally very expensive and requires expert advice from the manufacturers. Rather than give suggestions on this specialized subject, I would recommend anyone interested in it contacting one of the several companies that produce these units.

If any of you are now interested in obtaining a good fire extinguisher unit (and you ALL should be!) then I would suggest that as a start, you obtain from your local library the February 1985 issue of Practical Boat Owner magazine - this has several pages devoted to fire fighting and relates equally well to glassfibre cars and glassfibre boats. There is a list of fire units, types, capacities, prices and manufacturer's names and addresses.

Barry Gibbs.

SHAW ASSOCIATES

140 Lansdowne Crescent
Derry Hill, Nr. Calne
Wiltshire
SN119NU
Tel: (0249) 813169

November 1st, 1985.

Mr T. Faithfull
Hustlers Owners Club
4 Lodge Close
Church Lane East
Aldershot
HANTS GU11 3TA

Dear Sir,

I am writing to introduce our latest product, MS1-25450, which has been formulated specially to meet the demand from the Kit and Component Car industry for a method to facilitate the use of radio receivers in GRP vehicles.

MS1-25450 is an effective shield against stray electro magnetic radiation, which is the main source of interference experienced when radio receivers are installed in GRP based vehicles.

MS1-25450 maybe applied as a paint (by spray gun or by brushing) on all the non-metallic surfaces in the engine compartment either during the assembly of the cars or even after completion, subject to being able to reach all the non-metallic inside surfaces around the car's engine bay.

The cost of MS1-25450 is 35 plus VAT and PSP for sufficient to cover the inside surfaces of the engine compartment of one car, and is supplied in a screw top can with full application instructions.

I would be most grateful if you would, as a service to your members, make this known amongst the membership of your club.

Yours faithfully

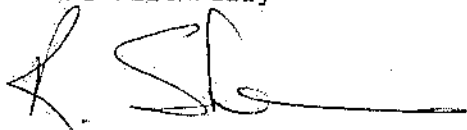

R. Shaw Ph.D., M.Sc.

I found this article while sorting through some old papers in the attic. It looks like it came from an old issue of Alternative Cars Magazine. I know I must be breaking all sorts of copyright restrictions but I'll take a chance. I believe its a good modification to make.

BELT AND BRACES

One of the most annoying of the few faults to be found on BL's 'A' series engine is premature wear of the timing chain which gives rise to the most hideous clatter at tickover. One solution is to fit a set of double row sprockets and chain, but a much more refined and permanent way round the problem is to fit a toothed belt conversion kit. Here Chris Horton shows what is involved.

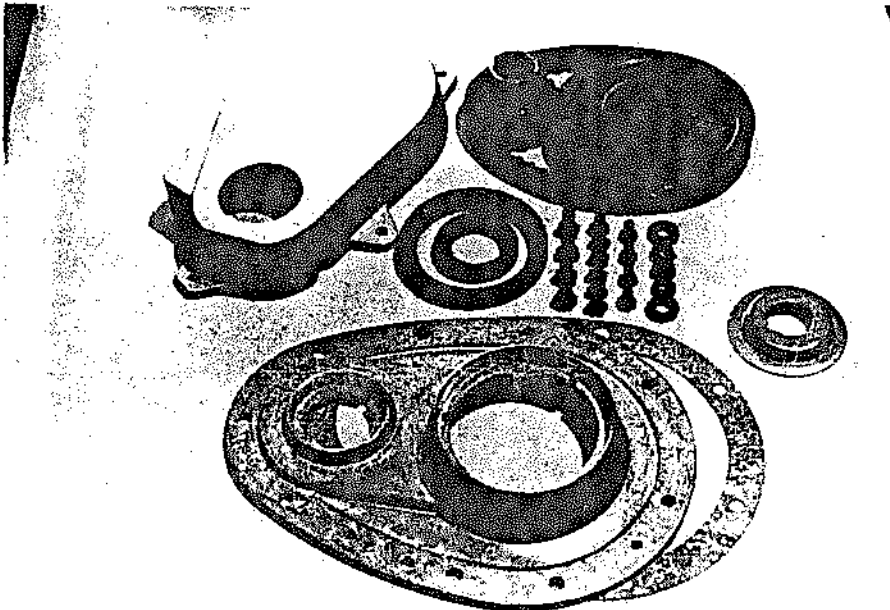

What you get for your money. Literally everything required to do the job is supplied, even a new gasket and full set of bolts.

We were impressed; not only did our UVA-supplied timing belt kit for the Leyland 'A' series actually fit without any drama whatsoever, it also does exactly what it is supposed to and makes a normally fairly noisy engine as quiet as the proverbial mouse . . . and the nice thing is you can then virtually forget about it!

But before we go into the technicalities of fitting the belt it might be a good idea to explain why it is needed. As you may know, the BL 'A' series engine, in virtually all its forms, suffers from the most infuriating timing chain rattle even after as little as five thousand miles. This is less of a problem on 1300 engines because a double row chain is used, but the characteristic sound of any well-used Mini, Allegro, Sprite, Morris Minor or 1100 is that accursed rattling. Naturally the smaller engines can be uprated simply by fitting the double row chain from the larger units or else one of the many proprietary kits from a tuning specialist, but how much better it would be to use some rather more

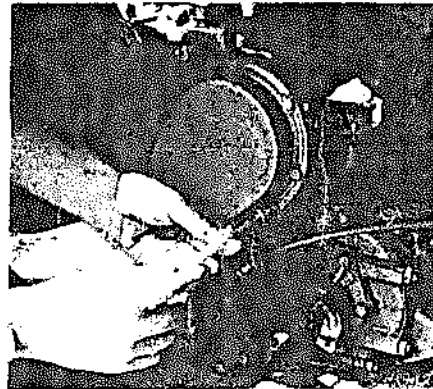

Having removed the pulley (a tap with a hide hammer should do the trick) release all the bolts round the cover.

modern technology that can actually make a significant improvement to the engine's reliability; after all if a rubber belt cam drive is good enough for BDA . . .

So having relieved Alan Arnold of one of his newly imported kits (they come from

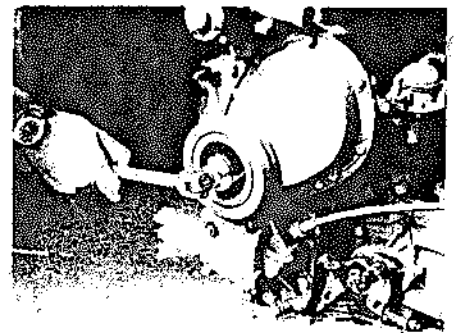

After bending back the locktab a 1 1/16" AF socket can be used to undo the crankshaft pulley nut; it's tight!

cramped Mini-based kits; hopefully this feature will be timed so that some of you at least can take advantage of it before fitting the engine in the first place!

The first step was to bend back the locktab on the crankshaft pulley nut, and then using a large socket (1 1/16" AF) we undid the nut itself; the best way of locking the engine is to take off the starter motor

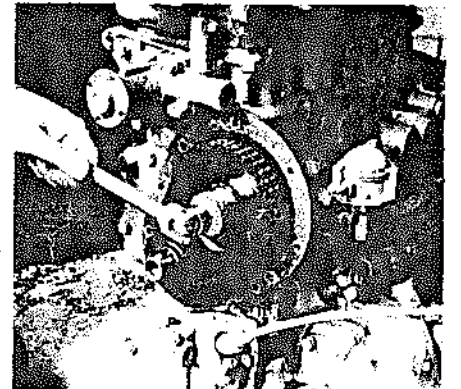

Removing the cover exposes another locktab to be bent back; you can then undo the camshaft chainwheel nut.

and wedge a screwdriver blade against the teeth of the ring gear. Fortunately the pulley itself came off with a gentle tap from a hide hammer, then we could remove the 1/2" and 7/16" AF bolts round the timing cover. We then prised the cover off and

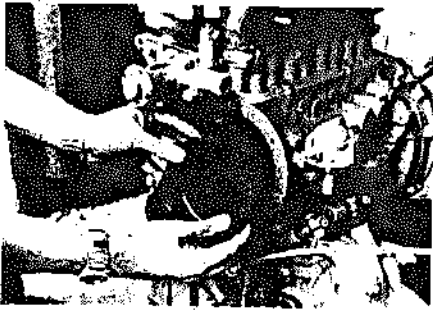

Pull off both chainwheels together so that the chain doesn't jam them; you may need to lever off the larger sprocket.

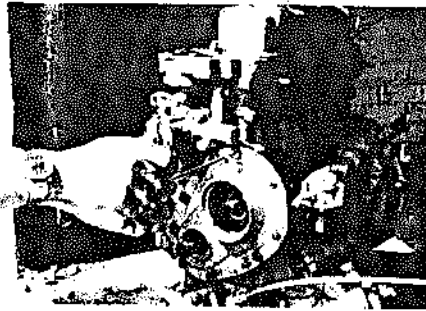

Clean off the gasket face on the block; then fit the new gasket and cover with the bolts provided; tighten evenly.

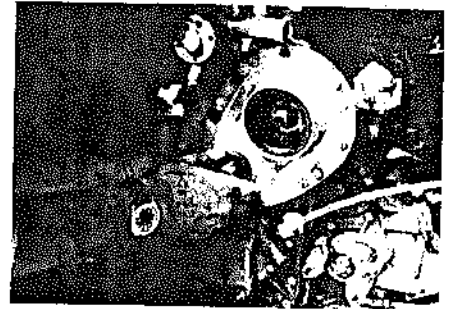

Our next job was to fit the two oil-seals; ideally you should press them home with a suitable piece of wood.

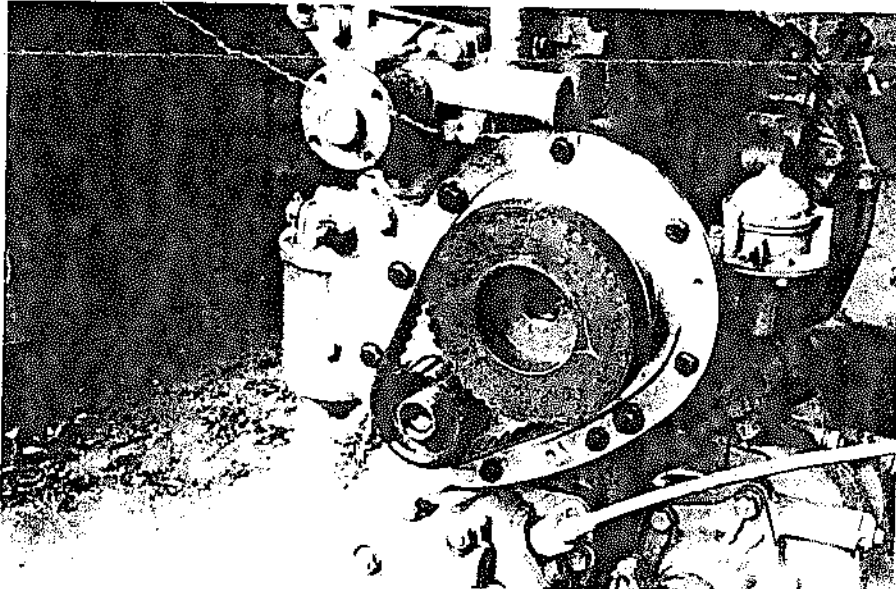

And here's what the new system looks like; we slid both sprockets on together, but had to use a little persuasion on the top one.

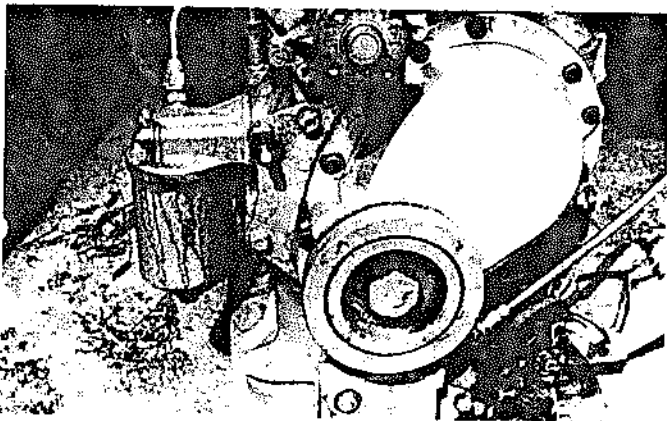

Finally, this is the completed installation, fitted with the attractive alloy cover supplied in the kit, and the standard crankshaft pulley.

carefully removed all traces of gasket that were left on the block face.

The next step, after taking off the oil thrower that you will find on the crank between the timing cover and the sprocket, was to turn the engine so that the timing marks on the two sprockets were opposite each other and then to bend back the locktab on the top (larger) of the two chainwheels. Then after locking the engine again, we removed the nut securing the wheel to the camshaft with the same large socket that we used for the crankshaft pulley. It was then a case of drawing both chainwheels off together, complete with the chain joining them; the

bottom chainwheel will usually slide off very easily but the top one may need a little persuasion with a couple of screwdrivers levering behind it, or possibly the use of a universal puller. But whatever method you have to use, do be careful to pull both wheels forward together or the rigidity of the chain will jam them on their shafts.

With all the old bits out of the way, the next stage is the rather nicer one of bolting on the new. Begin by attaching the new alloy backing plate to the block face with the relevant bolts and washers provided, not forgetting the new gasket that is supplied, but note that you will first have to fit the oil seals to their housings. In fact we

cheated by tapping them in with a soft hammer after the housing had been fitted, but ideally you should use a largish piece of wood to spread the load as you drift them in. With the bolts tightened, the next stage is to fit the toothed rubber belt itself along with its special sprockets; hopefully you won't have disturbed either the crankshaft or camshaft since disconnecting them earlier, so once you have lined up the timing marks on the two new sprockets they should more or less slide straight on to their respective shafts at the same time as the belt. The smaller, lower sprocket is a simple keyed fit on its shaft which should present no problem, but you may have to use a bit of gentle persuasion to get the other one on. Refit the camshaft locktab and nut, replace the new oil thrower/dust seal on the end of the crank, and then fit the attractive alloy cover over the whole assembly; after that the last stage is simply to refit the crankshaft pulley, and then its locktab and retaining bolt, making sure to tighten the latter to the right torque . . . if you don't possess a torque wrench just do it up good and tight, locking the engine by the screwdriver against the ring gear again.

And that is about it; we think you will agree that it was pleasantly easy! The whole job (although remember that we didn't have to remove the engine and had plenty of room in which to work) took us about an hour, an investment of time and money that pays handsome dividends as soon as you start the engine. And no, we have no qualms about using a rubber timing belt; experience has shown them to be just as good as, if not vastly superior, to conventional chains. Quite apart from their silence of operation, long life and the fact that they don't need lubrication, rubber belts strike us as a much more elegantly engineered way of transmitting drive between engine components, and we have every confidence that the one we have just fitted will last at least 100,000 miles if need be, although the manufacturers do recommend that the specially made Pirelli belt supplied with the kit is changed at 20,000 mile intervals. For the money, I don't think you can say fairer than that!

CLUB SWEATSHIRTS

1. **SIZES** Chest or bust size in inches. 2" size steps

1. Inches	22	24	26	28	30	32	34	36	38	40	42	44	46	48	50
2. Ladies' Bust						10	12	14	16	18	20	22	24	26	28
3. Men's Collar						13½	14	14½	15	15½	16	16½	17	17½	18
4. Children's Ages	2	4	6	8	10										

A. LOOK AT THE PRICE GUIDE

Item	Price Guide	
	From	Average
T Shirts	1.95	4.95
Sweatshirts	4.95	8.95
Sports Shirts	6.95	12.95
Men's Shirts	6.95	10.95
Ladies' Blouses	6.95	10.95
Overalls	19.95	24.95
Jogsuits	19.95	24.95
Tracksuits	24.95	29.95

04868 7068

04868 7068

The address for those who wish to visit the shop is:

3 New Road, MILFORD. Surrey.
On the A3 next to the White Lion Pub!

Club Badges as on the right.
Cloth, Black & White.
£1.20 each.

Club Keyrings as on the left. 30. pence each.
Cheques made payable to 'Hustler Owners Club'.

Send to :
Trevor Faithfull
4 Lodge Close
Church Lane East.
ALDRSHOT
Hants GU11 3TA

